

**PRODUCT INFORMATION**

**ITEM NUMBER(S)** 01.339380.01.001



**ITEM DESCRIPTION** Cordless Vacuum Cleaner

**1.1.A** The unequivocal identification of the product (type of product, trademark, trade name, model and possibly serial number)



Smartwares Group | Swaardvenstraat 65  
5048AV Tilburg | The Netherlands

Silent Storm Cordless Vacuum  
Model No.: 01.339380.01.001  
Adapter input: 100-240V ~ 50/60Hz 0.5A max  
Adapter output: 26.5V DC 0.5A  
Battery: Li-Ion 22.2V DC / 2200 mAh rechargeable  
Batch number: T30238  
www.princesshome.eu

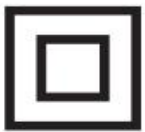
Do not immerse in any liquid / Niet in water onderdompelen /  
Ne pas plonger dans l'eau / Nicht ins Wasser hineintauchen

**1.1.B** A disassembly map or exploded view

BOM List		
Item no.	Name	Type/Material
31	power brush	Assy
30	tube	Assy
29	speed switch	ABS
28	battery shell cover	ABS
27	speed switch panel	PCB
26	battery pack	Assy
25	battery shell	ABS
24	battery lining	ABS
23	battery lock	ABS
22	realse button spring	Stainless steel
21	switch holder	ABS
20	handle	ABS
19	handle cover	ABS
18	dust cup cover	Transparent ABS
17	metal mesh	ABS
16	HEPA	Assy
15	dust release button	ABS
14	conducting needle base	ABS
13	conducting needle	Copper
12	conducting needle base cover	ABS
11	suction nozzel	ABS
10	suction nozzle lining	ABS
9	dust cup	Transparent ABS
8	dust cup assy body	ABS
7	motor sealing ring	Rubber
6	motor	Assy
5	motor wedge	Rubber
4	light board	ABS
3	dust cup cover	ABS
2	decoration panel	ABS
1	dispaly panel	ABS

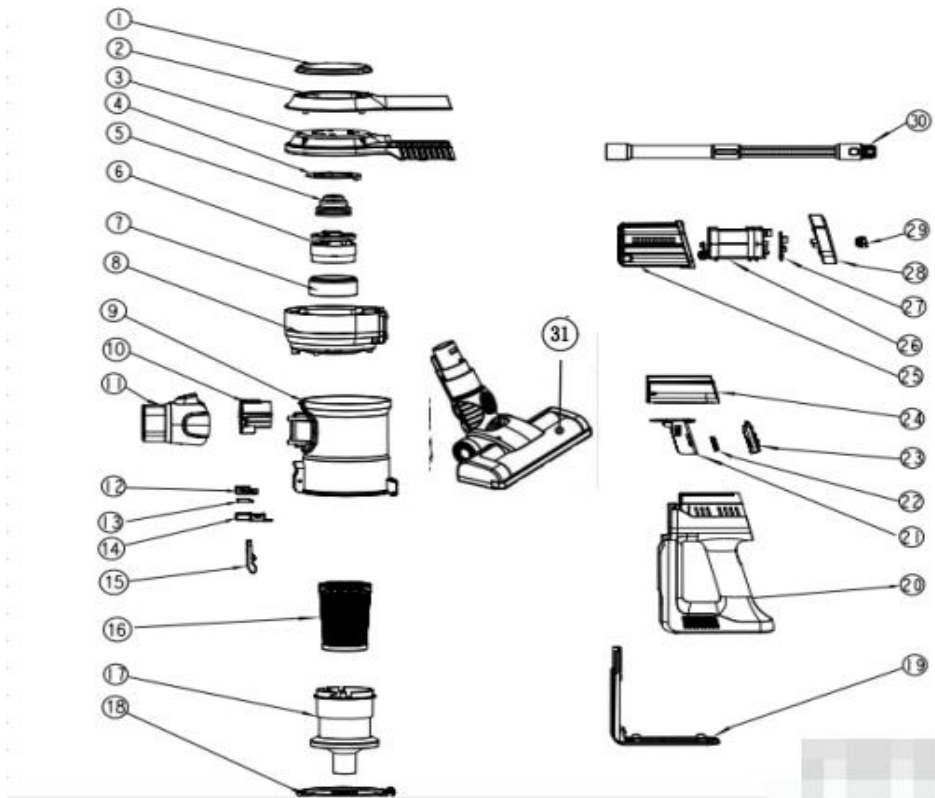

1.1.C

Wiring and connection diagrams

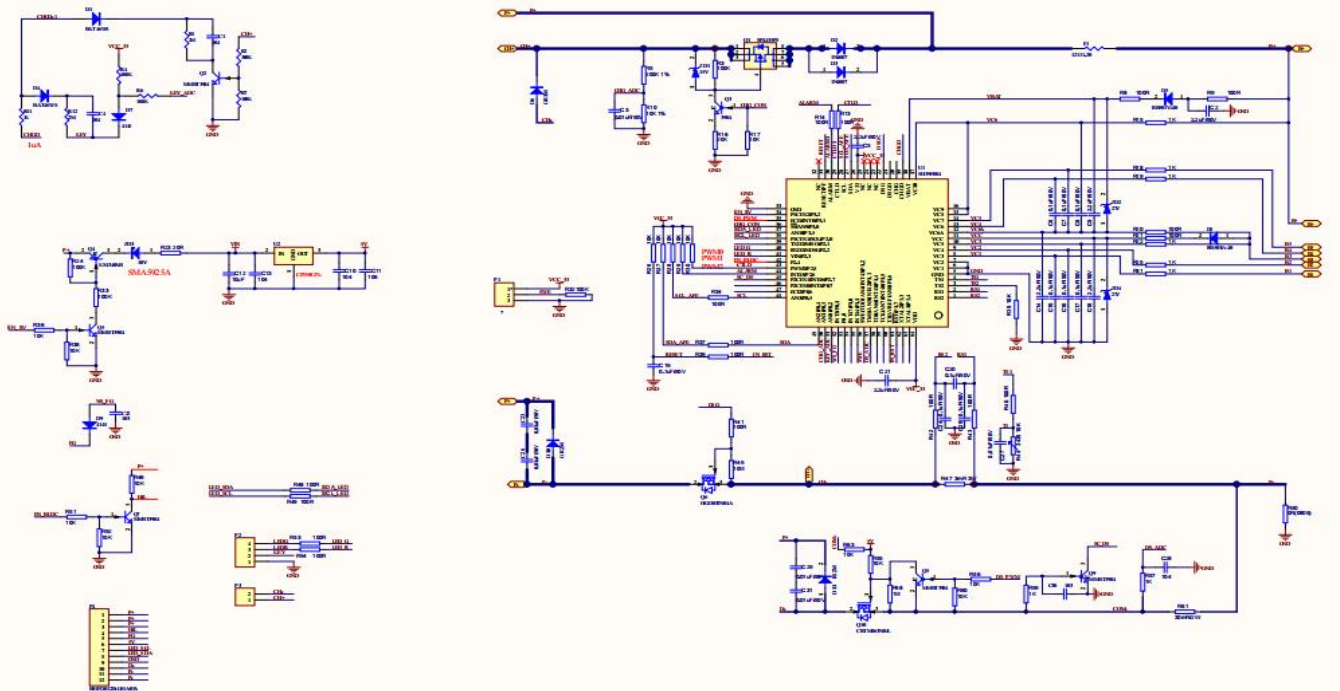

## 1.1.D

## Electronic boards diagrams

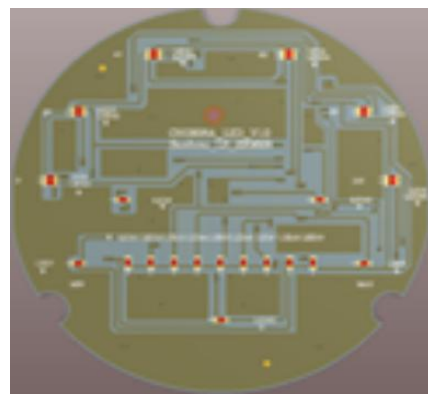
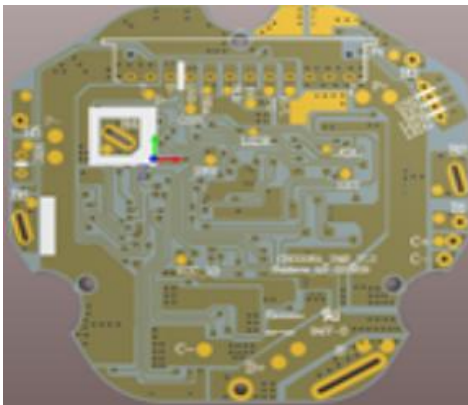
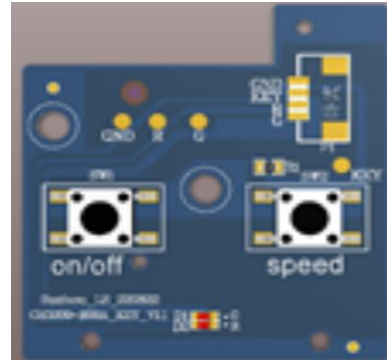

## 1.1.E

## List of necessary repair and test equipment

NOT APPLICABLE

## 1.1.F

## Technical manual of instructions for repair

NOT APPLICABLE

## 1.1.G

## Diagnostic fault and error codes

NOT APPLICABLE

## 1.1.H

## Component and diagnosis information

NOT APPLICABLE

## 1.1.I

## (including reset software)

NOT APPLICABLE

## 1.1.J

## Information on how to access data records of reported failur incidents stored on the product

NOT APPLICABLE

整机电压 (V) :	22.2	年不良率 :	2%	产品图片 :	
整机功率 (W) :	160	尘杯最大容积 (L) :	0.7		
整机寿命 (h) :	≥150	尘杯有效容积 (L) :	0.5		
最大吸入功率 (W) :	≥40	尘杯分离效率 (%) :	90		
最大真空度 (KPa) :	≥11	尘杯过滤效率 (%) :	97		
最大风量 (L/s) :	≥10	无吸力损耗 (%) :	40		
整机效率 (%) :	≥28	调速档位 :	3档		
噪音 (dB(A)) :	≤75	电量显示 (Y/N) :	Y		
进风过滤方式/等级 :	海帕/H11	尘满指示 (Y/N) :	N		
出风过滤方式/等级 :	海绵	接管类型 :	铝管		
地刷类型 :	电动地刷	接管长度 (mm) :	635	附件配置 :	小方刷, 长扁吸, 电动地刷
地刷口径 (mm) :	34	接管口径 (mm) :	34	配件放置方式 :	挂架
地刷堵转保护 (Y/N) :	Y	主机放置方式 :	地刷站立固定	充电时间 (h) :	4.5±0.5
主电机 (电机组件) 参数 :	型号 :	55-3 (晨光) DC01	电池参数 :	放电时间 (高档) (min) :	≥15
	绝缘等级 :	E		放电时间 (中档) (min) :	≥18
	标称功率 (W) :	140±10%		放电时间 (低档) (min) :	≥30
	标称电压 (V) :	22.2		电池包电压 (V) :	22.2
	转速 (rpm) :	85000±10%		电芯容量 (mAh) :	2200
	最大吸入功率 (W) :	≥66		电芯规格 :	1NR18650-2200mAh
	最大真空度 (KPa) :	≥20		电芯供应商 :	天鹏
	最大风量 (L/s) :	13		电芯内阻 (mΩ) :	<18
	最大效率 (%) :	≥50		电池包内阻 (mΩ) :	30
	负载电流 (A) :	8		电池包是否可拆卸 :	Y
振动 (mm/s) :	12	电池包认证 :	Y		
寿命 (h) :	≥500	充放电循环次数 :	300个循环容量 ≥80%		
主地刷电机参数 :	型号 :	DC02	适配器参数 :	适配器型号 :	RKGSDC2650500
	绝缘等级 :	E		适配器线长 (m) :	1.2±0.1
	标称功率 (W) :	15±10%		适配器规格 :	26.5V 500mA
	标称电压 (V) :	22.2		充电电流 (A) :	0.5±10%
	地刷额定功率 (W) :	15		适配器供应商 :	泰裕
	地刷空转电流 (A) :	≤0.5	适配器插头类型 :	CCC, VDE, UL, BS	
	滚刷转速 (R/min) :	2500±500	适配器认证 :	UL, VDE, CCC, CB	
	滚刷是否可拆卸 :	Y	包装信息	彩盒尺寸 (cm) :	65*30*14.5
	地刷照明 :	Y		整机净重 (Kg) :	2.77
	电机品牌及型号 :	晨光		外箱尺寸 (cm) :	4in1: 66*30.5*62
电机寿命 (h) :	200	毛重 (Kg) :		4in1: 16.15	
电机转速 (R/min) :	7500±500	产品尺寸		产品外形尺寸 :	32.5*12.2*21.5
电机过流保护值 :	2A		手持部分净重 (Kg) :	1.375	
滚刷类型 :	尼龙毛条				

## 1.1.L

Specific guidance for self-repair (recommended operations, safety and repair instruction, any implications for the guarantee)

NOT APPLICABLE

## 1.1.M

How to get access to professional repairers

NOT APPLICABLE

## 1.1.N

Failures detection and required action (consumers approach)

NOT APPLICABLE





- EN User manual
- NL Gebruiksaanwijzing
- FR Manuel de l'utilisateur
- DE Benutzerhandbuch
- PL Instrukcja obsługi
- CS Uživatelská příručka
- IT Manuale dell'utente
- SK Uživatelská príručka
- ES Manual del usuario
- PT Manual do utilizador
- SV Bruksanvisning



# Stick Vacuum

01.339380.01.001  
01.339390.01.001

(EN) User manual	5	(IT) Manuale dell'utente	41
(NL) Gebruiksaanwijzing	10	(SK) Uživatelská príručka	47
(FR) Manuel de l'utilisateur	16	(ES) Manual del usuario	53
(DE) Benutzerhandbuch	22	(PT) Manual do utilizador	59
(PL) Instrukcja obsługi	29	(SV) Bruksanvisning	65
(CS) Uživatelská příručka	35		

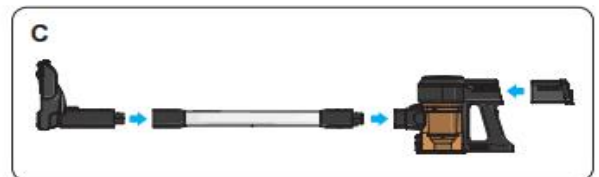
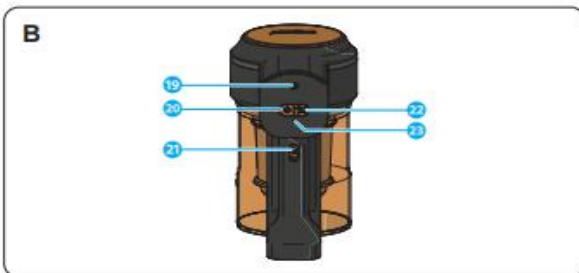
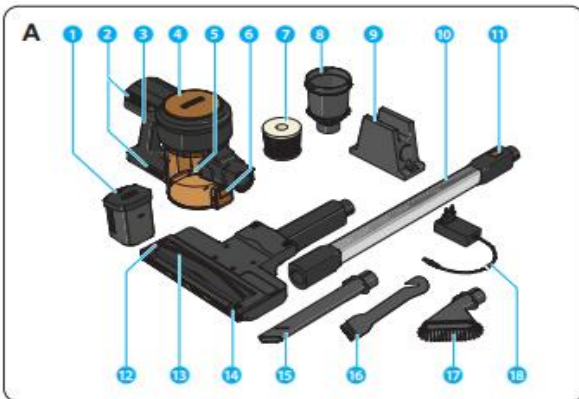



## Stick Vacuum

### FOREWORD

#### About this document

This user manual contains all the information for correct, safe, and efficient use of the appliance. Ensure you have fully read and understood the instructions in this user manual before you use the appliance.

Always store this user manual in a safe place near the appliance for future reference.

#### Original instructions

This manual is originally written in English. All other languages are translated documents.

#### Support

For spare parts and more information about the appliance, please visit [www.princesshome.eu](http://www.princesshome.eu)

#### Symbols used

Symbol	Description
	<b>WARNING</b> Signal word used to indicate a potentially hazardous situation which, if not avoided, could result in death or serious injury.
	<b>CAUTION</b> Signal word used to indicate a potentially hazardous situation which, if not avoided, could result in minor or moderate injury.
	<b>NOTICE</b> Signal word used to address practices not related to physical injury.
	Indicates additional information or emphasis on an instruction.

#### APPLIANCE DESCRIPTION

##### About this appliance

The Princess 01.339380.01.001 / 01.339390.01.001 is a wireless stick vacuum for cleaning small and large spaces. The appliance comes with multiple accessories and a wall mount for easy storing.

##### Intended use

This appliance is intended for dry vacuuming.

This appliance is intended for indoor use only.

This appliance is not intended for vacuuming concrete, tarmac/adam or other rough surfaces.

This appliance is intended exclusively for domestic, non-commercial use.

This appliance is intended to be used in household and similar applications such as:

- staff kitchen areas in shops, offices and other working environments;
- farmhouses;
- by clients in hotels, motels, and other residential type environments;
- bed and breakfast type environments.

This appliance can be used by children aged from 8 years and above and persons with reduced physical, sensory or mental capabilities or lack of experience and knowledge if they have been given supervision or instruction concerning use of the appliance in a safe way and understand the hazards involved. Children shall not play with the appliance. Cleaning and user maintenance shall not be made by children without supervision.

Only use the appliance as described in this user manual.

Any use of the appliance other than described in this user manual is regarded as misuse and may cause injury or damage to the appliance and void the warranty.

#### Main parts (see image A)

- Battery
- Air vents
- Handle
- Main body
- Dust container
- Dust container lid release button
- HEPA filter
- Filter housing
- Wall mount/accessory holder
- Tube
- Tube release button
- Brush bar lock
- Brush bar
- Brush head
- Crevice nozzle
- Cleaning tool
- Furniture brush
- Adapter

#### Control panel (see image B)

- Charging port
- On/off button
- Battery release button
- Speed button
- Charging indicator LED

## SAFETY

### Safety precautions

#### **WARNING**

##### Electric shock hazard due to short-circuiting:

- Never use the appliance if there are visible signs of damage or defects to the appliance or adapter. Always replace a damaged or defective appliance or adapter immediately or contact customer service.
- Never immerse the appliance in water or other liquids.
- Always avoid spillage on the adapter.
- Never lift the appliance or the battery by the adapter. Lifting the appliance or battery by the adapter may damage the adapter. Only lift the appliance by holding the base.
- Always check if the voltage stated on the type plate of your appliance matches your mains voltage before use.
- Never insert any objects into the air vent openings.
- Use only an external supply with the following specifications: 100 – 240 V ~ 50 / 60 Hz, 0.5 A.
- Always remove the battery before cleaning or maintaining the appliance.
- Never handle the appliance or the battery with wet hands.
- Always pull/grasp the plug to unplug the adapter from the appliance.
- Never wrap the adapter around the appliance.

##### Safety hazard for children:

- Children should be supervised to ensure that they do not play with the appliance.

##### Fire hazard due to short-circuiting:

- Never drop the appliance and avoid bumping. Excessive vibrations can lead to loosened connections and can influence proper functioning of the appliance. Stop using the appliance if the appliance has been dropped.
- Never use the appliance with an extension cable.
- Always keep the battery away from small metal objects when the battery is removed from the appliance.

##### Explosion hazard due to overheating:

- Never expose the battery to high temperatures or fire.

##### Fire hazard due to overheating:

- Never cover the appliance or the air vents when in use.
- Only charge the appliance in a well-ventilated area.

##### Burning hazard due to chemical fluids:

- Always avoid eye or skin contact with the battery acid in event of a leaking battery. In case of contact with the battery acid, immediately flush the eyes or skin with water. Consult a doctor immediately.

##### Choking hazard due to plastic packaging:

- Never let children play with the packaging material. Always keep the packaging material out of the reach of children.

##### Snagging hazard due to moving parts:

- Always keep your hair and clothing away from moving parts. Loose clothes, jewellery or long hair can be caught in moving parts.

#### **CAUTION**

##### Tripping hazard due to loose cables:

- Never leave the adapter hanging out in a way that someone might trip over it or accidentally pull it.

## NOTICE

### Risk of damaging the appliance:

- Never use aggressive chemical cleaning agents that can damage the appliance when cleaning the appliance.
- Only use the appliance with the provided accessories or accessories recommended by Princess.
- Never place the appliance near a heat source.
- Never place the appliance in a dishwasher.
- Never vacuum liquids, hot debris or any flammable substances with the appliance.
- Never use the appliance with a full dust container. Overfilling the dust container may cause clogs and reduced suction.

### USE

#### Before first use (see image C)

1. Remove all packaging.
2. Insert the tube A into the main body A with the tube release button A facing up until you hear a click.
3. Insert the brush head A into the tube A with the release button facing up until you hear a click.
4. Insert the battery A into the main body A.

#### Charging the appliance

The battery A is empty if the charging indicator LED B flashes several times and then switches off. The battery A can be charged via the charging port B, both in the appliance and removed.

Optionally, pull the battery release button B down and remove the battery A.

1. Plug the adapter A into the charging port B.

2. Plug the other end of the adapter A into a power outlet.

The charging indicator LED B flashes green when the battery A is charging.

The charging indicator LED B lights up continuously green when the battery A is fully charged.

#### Using the appliance

1. Press the on/off button B to switch on the appliance.

The appliance switches on in medium speed.

2. Press the speed button B to cycle through high-, medium-, and low speed.

3. Press the on/off button B to switch off the appliance.

#### Using park mode / Active mode (see image D)

To park the appliance in the middle of a room:

1. Hold the handle A and push the main body A vertically until you hear the brush head A click.

To release the appliance from park mode:

1. Hold the handle A.
2. Place your foot on the brush head A and pull the handle A downwards until you hear the brush head A click.

#### Using the accessories

1. Press the tube release button A and pull the tube A out of the main body A.
2. Insert the crevice nozzle A or furniture brush A into the main body A until you hear a click.

1. The accessories can also be attached at the end of the tube A to reach hard to reach places.
1. The crevice nozzle A is ideal to vacuum hard to reach places.
1. The furniture brush A is ideal to vacuum hard surfaces and fabrics.

### CLEANING AND MAINTENANCE

Regularly clean the outside of the appliance with a dry cloth.

Empty the dust container A after each use to ensure optimal suction performance.

Regularly clean the HEPA filter A from the filter housing A to ensure optimal suction performance. Follow the instructions in chapter *Cleaning the filter*.

#### Cleaning the filter (see image E)

Make sure the appliance is switched off before cleaning and maintaining the appliance.

1. Press the dust container lid release button A above a dustbin to empty the dust container A.
2. Insert the crevice nozzle A into the bottom of the filter housing A.
3. Rotate the crevice nozzle A counter clockwise to release the filter housing A.
4. Remove the HEPA filter A from the filter housing A.
5. Tap the HEPA filter A above a dustbin to remove dust and debris.
6. Remove all debris from the HEPA filter A with the cleaning tool A.
- Regularly clean the HEPA filter A and filter housing A with water. Let the HEPA filter A and filter housing A dry completely before reassembling the appliance.
7. Insert the HEPA filter A into the filter housing A.
8. Insert the crevice nozzle A into the filter housing A.
9. Insert the filter housing A into the dust container A.
- Optionally, use your hands to insert the filter housing A.
10. Rotate the crevice nozzle A clockwise to secure the filter housing A.
11. Remove the crevice nozzle A from the filter housing A.
12. Close the dust container A until you hear a click.

#### Cleaning the brush head and brush bar (see image F)

Make sure the appliance is switched off before cleaning and maintaining the appliance.

1. Press the release button on the brush head A to remove the brush head A.
2. Slide the brush bar lock A outwards to unlock the brush bar A.
3. Take the brush bar A out of the brush head A.
4. Remove all hair and debris from the brush bar A and brush head A with the cleaning tool A.
- Optionally, clean the brush bar A with water. Let the brush bar A dry completely for 24 hours.
5. Insert the brush bar A back into the brush head A.
6. Slide the brush bar lock A inwards to lock the brush bar A.

### STORAGE

Store the appliance indoors, in a dry place and out of reach of children.

The wall mount/accessory holder A can be clipped to the tube A to have all accessories at hand when using the appliance.

Optionally, store the appliance using the wall mount/accessory holder A:

1. Mount the wall mount/accessory holder A to a wall. Make sure to use the appropriate wall plugs and screws for your wall.
1. The wall mount/accessory holder A is not intended to hold the appliance without support. Mount the wall mount/accessory holder A at a height where the brush head A can reach the ground.
2. Insert the crevice nozzle A and the furniture brush A to the top and bottom of the wall mount/accessory holder A.

3. Put the appliance in park mode. Follow the instructions in chapter *Using Park mode/Active mode*.
4. Insert the appliance into the front of the wall mount/accessory holder A.

### TROUBLESHOOTING

Problem	Possible cause	Possible solution
The appliance does not work / is not working properly.	The battery A is not inserted.	Insert the battery A.
	The battery A is empty.	Charge the battery A.
	The appliance is switched off.	Press the on/off button B to switch on the appliance.
The appliance stops working.	The dust container A is full.	Empty the dust container A.
	The HEPA filter A is dirty.	Clean the HEPA filter A.
The battery A does not charge.	The battery A is empty.	Charge the battery A.
	The HEPA filter A is dirty.	Clean the HEPA filter A.
The brush bar A does not work.	The adapter A is not properly connected to a working power outlet.	Plug the adapter A into a working power outlet.
	The brush bar A is not inserted correctly. The brush bar A is blocked.	Correctly insert the brush bar A. Clean the brush bar A and brush head A to remove the blockage.

### DISPOSAL

Follow the local regulations when you need to dispose the appliance. To prevent possible harm to the environment or human health from uncontrolled waste disposal, recycle the appliance responsibly to promote the sustainable reuse of material resources.