

PRODUCT INFORMATION

ITEM NUMBER(S) 01.333001.01.001

ITEM DESCRIPTION Bagged Vacuum Cleaner

1.1.A The unequivocal identification of the product (type of product, trademark, trade name, model and possibly serial number



Jules Verneweg 87
5015BH Tilburg
The Netherlands

Vacuum Cleaner Power DeLuxe

220-240V~ 50/60Hz 700W

Article No.: 01.333001.01.001

Batch No.: T01417

www.princesshome.eu





Do not immerse in any liquid / Niet in water onderdompelen
Ne pas plonger dans l'eau / Nicht ins Wasser hineintauchen



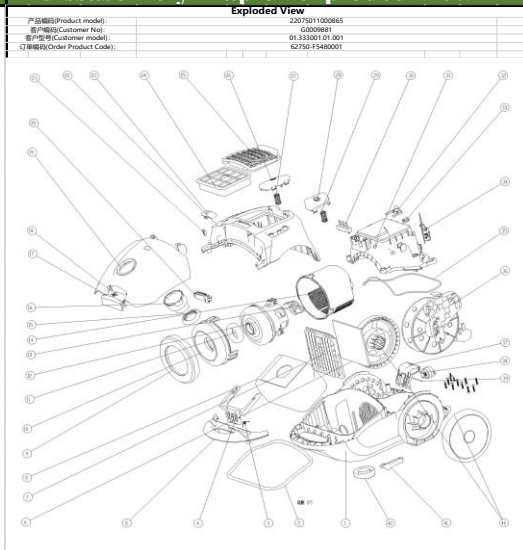

1.1.B A disassembly map or exploded view

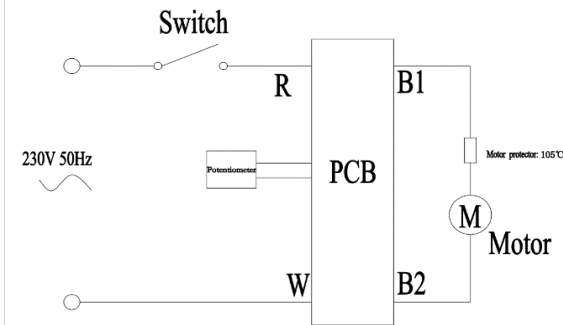

| Qty | Part Name | Part No. | Rev. | Part Status | Drawing No. | MIN. QTY | Unit Price USD | Remarks |
|-----|----------------|--------------|------|-------------|-------------|----------|----------------|---------|
| 1 | Motor Assembly | 121750000100 | 1 | NA | NA | 20 | | |
| 1 | Roller | 121750000101 | 1 | NA | 0207-15 | 20 | | |
| 1 | Roller | 121750000102 | 1 | NA | 0207-15 | 20 | | |
| 1 | Roller | 121750000103 | 1 | NA | 0207-15 | 20 | | |
| 1 | Roller | 121750000104 | 1 | NA | 0207-15 | 20 | | |
| 1 | Roller | 121750000105 | 1 | NA | 0207-15 | 20 | | |
| 1 | Roller | 121750000106 | 1 | NA | 0207-15 | 20 | | |
| 1 | Roller | 121750000107 | 1 | NA | 0207-15 | 20 | | |
| 1 | Roller | 121750000108 | 1 | NA | 0207-15 | 20 | | |
| 1 | Roller | 121750000109 | 1 | NA | 0207-15 | 20 | | |
| 1 | Roller | 121750000110 | 1 | NA | 0207-15 | 20 | | |
| 1 | Roller | 121750000111 | 1 | NA | 0207-15 | 20 | | |
| 1 | Roller | 121750000112 | 1 | NA | 0207-15 | 20 | | |
| 1 | Roller | 121750000113 | 1 | NA | 0207-15 | 20 | | |
| 1 | Roller | 121750000114 | 1 | NA | 0207-15 | 20 | | |
| 1 | Roller | 121750000115 | 1 | NA | 0207-15 | 20 | | |
| 1 | Roller | 121750000116 | 1 | NA | 0207-15 | 20 | | |
| 1 | Roller | 121750000117 | 1 | NA | 0207-15 | 20 | | |
| 1 | Roller | 121750000118 | 1 | NA | 0207-15 | 20 | | |
| 1 | Roller | 121750000119 | 1 | NA | 0207-15 | 20 | | |
| 1 | Roller | 121750000120 | 1 | NA | 0207-15 | 20 | | |
| 1 | Roller | 121750000121 | 1 | NA | 0207-15 | 20 | | |
| 1 | Roller | 121750000122 | 1 | NA | 0207-15 | 20 | | |
| 1 | Roller | 121750000123 | 1 | NA | 0207-15 | 20 | | |
| 1 | Roller | 121750000124 | 1 | NA | 0207-15 | 20 | | |
| 1 | Roller | 121750000125 | 1 | NA | 0207-15 | 20 | | |
| 1 | Roller | 121750000126 | 1 | NA | 0207-15 | 20 | | |
| 1 | Roller | 121750000127 | 1 | NA | 0207-15 | 20 | | |
| 1 | Roller | 121750000128 | 1 | NA | 0207-15 | 20 | | |
| 1 | Roller | 121750000129 | 1 | NA | 0207-15 | 20 | | |
| 1 | Roller | 121750000130 | 1 | NA | 0207-15 | 20 | | |
| 1 | Roller | 121750000131 | 1 | NA | 0207-15 | 20 | | |
| 1 | Roller | 121750000132 | 1 | NA | 0207-15 | 20 | | |
| 1 | Roller | 121750000133 | 1 | NA | 0207-15 | 20 | | |
| 1 | Roller | 121750000134 | 1 | NA | 0207-15 | 20 | | |
| 1 | Roller | 121750000135 | 1 | NA | 0207-15 | 20 | | |
| 1 | Roller | 121750000136 | 1 | NA | 0207-15 | 20 | | |
| 1 | Roller | 121750000137 | 1 | NA | 0207-15 | 20 | | |
| 1 | Roller | 121750000138 | 1 | NA | 0207-15 | 20 | | |
| 1 | Roller | 121750000139 | 1 | NA | 0207-15 | 20 | | |
| 1 | Roller | 121750000140 | 1 | NA | 0207-15 | 20 | | |
| 1 | Roller | 121750000141 | 1 | NA | 0207-15 | 20 | | |
| 1 | Roller | 121750000142 | 1 | NA | 0207-15 | 20 | | |
| 1 | Roller | 121750000143 | 1 | NA | 0207-15 | 20 | | |
| 1 | Roller | 121750000144 | 1 | NA | 0207-15 | 20 | | |
| 1 | Roller | 121750000145 | 1 | NA | 0207-15 | 20 | | |
| 1 | Roller | 121750000146 | 1 | NA | 0207-15 | 20 | | |
| 1 | Roller | 121750000147 | 1 | NA | 0207-15 | 20 | | |
| 1 | Roller | 121750000148 | 1 | NA | 0207-15 | 20 | | |
| 1 | Roller | 121750000149 | 1 | NA | 0207-15 | 20 | | |
| 1 | Roller | 121750000150 | 1 | NA | 0207-15 | 20 | | |
| 1 | Roller | 121750000151 | 1 | NA | 0207-15 | 20 | | |
| 1 | Roller | 121750000152 | 1 | NA | 0207-15 | 20 | | |
| 1 | Roller | 121750000153 | 1 | NA | 0207-15 | 20 | | |
| 1 | Roller | 121750000154 | 1 | NA | 0207-15 | 20 | | |
| 1 | Roller | 121750000155 | 1 | NA | 0207-15 | 20 | | |
| 1 | Roller | 121750000156 | 1 | NA | 0207-15 | 20 | | |
| 1 | Roller | 121750000157 | 1 | NA | 0207-15 | 20 | | |
| 1 | Roller | 121750000158 | 1 | NA | 0207-15 | 20 | | |
| 1 | Roller | 121750000159 | 1 | NA | 0207-15 | 20 | | |
| 1 | Roller | 121750000160 | 1 | NA | 0207-15 | 20 | | |
| 1 | Roller | 121750000161 | 1 | NA | 0207-15 | 20 | | |
| 1 | Roller | 121750000162 | 1 | NA | 0207-15 | 20 | | |
| 1 | Roller | 121750000163 | 1 | NA | 0207-15 | 20 | | |
| 1 | Roller | 121750000164 | 1 | NA | 0207-15 | 20 | | |
| 1 | Roller | 121750000165 | 1 | NA | 0207-15 | 20 | | |
| 1 | Roller | 121750000166 | 1 | NA | 0207-15 | 20 | | |
| 1 | Roller | 121750000167 | 1 | NA | 0207-15 | 20 | | |
| 1 | Roller | 121750000168 | 1 | NA | 0207-15 | 20 | | |
| 1 | Roller | 121750000169 | 1 | NA | 0207-15 | 20 | | |
| 1 | Roller | 121750000170 | 1 | NA | 0207-15 | 20 | | |
| 1 | Roller | 121750000171 | 1 | NA | 0207-15 | 20 | | |
| 1 | Roller | 121750000172 | 1 | NA | 0207-15 | 20 | | |
| 1 | Roller | 121750000173 | 1 | NA | 0207-15 | 20 | | |
| 1 | Roller | 121750000174 | 1 | NA | 0207-15 | 20 | | |
| 1 | Roller | 121750000175 | 1 | NA | 0207-15 | 20 | | |
| 1 | Roller | 121750000176 | 1 | NA | 0207-15 | 20 | | |
| 1 | Roller | 121750000177 | 1 | NA | 0207-15 | 20 | | |
| 1 | Roller | 121750000178 | 1 | NA | 0207-15 | 20 | | |
| 1 | Roller | 121750000179 | 1 | NA | 0207-15 | 20 | | |
| 1 | Roller | 121750000180 | 1 | NA | 0207-15 | 20 | | |
| 1 | Roller | 121750000181 | 1 | NA | 0207-15 | 20 | | |
| 1 | Roller | 121750000182 | 1 | NA | 0207-15 | 20 | | |
| 1 | Roller | 121750000183 | 1 | NA | 0207-15 | 20 | | |
| 1 | Roller | 121750000184 | 1 | NA | 0207-15 | 20 | | |
| 1 | Roller | 121750000185 | 1 | NA | 0207-15 | 20 | | |
| 1 | Roller | 121750000186 | 1 | NA | 0207-15 | 20 | | |
| 1 | Roller | 121750000187 | 1 | NA | 0207-15 | 20 | | |
| 1 | Roller | 121750000188 | 1 | NA | 0207-15 | 20 | | |
| 1 | Roller | 121750000189 | 1 | NA | 0207-15 | 20 | | |
| 1 | Roller | 121750000190 | 1 | NA | 0207-15 | 20 | | |
| 1 | Roller | 121750000191 | 1 | NA | 0207-15 | 20 | | |
| 1 | Roller | 121750000192 | 1 | NA | 0207-15 | 20 | | |
| 1 | Roller | 121750000193 | 1 | NA | 0207-15 | 20 | | |
| 1 | Roller | 121750000194 | 1 | NA | 0207-15 | 20 | | |
| 1 | Roller | 121750000195 | 1 | NA | 0207-15 | 20 | | |

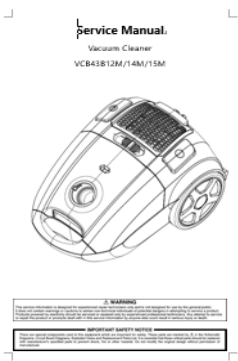
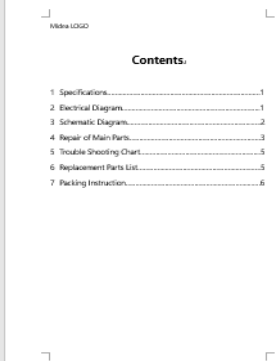
1.1.C Wiring and connection diagrams

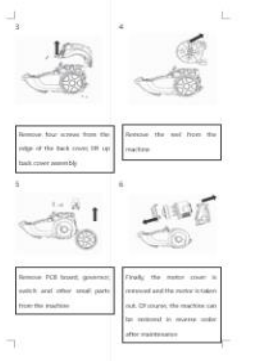
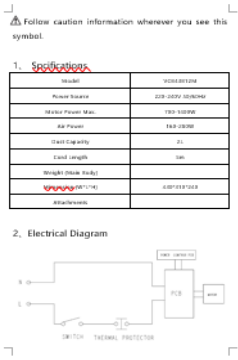
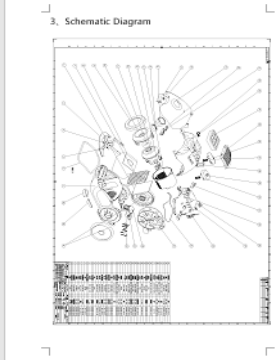

| | |
|-------|--|
| 1.1.D | Electronic boards diagrams |
| | NOT APPLICABLE |
| 1.1.E | List of necessary repair and test equipment |
| | 4.1 Repair Tools: +/- Screw Drivers, Air Performance Tester. |
| |  |
| 1.1.F | Technical manual of instructions for repair |
| | <div style="display: flex; flex-wrap: wrap;"> <div style="width: 50%;">  </div> <div style="width: 50%;">  </div> <div style="width: 50%;">  </div> <div style="width: 50%;">  </div> <div style="width: 50%;">  </div> <div style="width: 50%;">  </div> <div style="width: 50%;">  </div> <div style="width: 50%;">  </div> </div> |
| 1.1.G | Diagnostic fault and error codes |
| | NOT APPLICABLE |
| 1.1.H | Component and diagnosis information |
| | NOT APPLICABLE |
| 1.1.I | Instructions for software and firmware (including reset software) |
| | NOT APPLICABLE |
| 1.1.J | Information on how to access data records of reported failure incidents stored on the product |
| | NOT APPLICABLE |
| 1.1.K | Technical bulletins |
| | NOT APPLICABLE |
| 1.1.L | Specific guidance for self-repair (recommended operations, safety and repair instruction, any implications for the guarantee) |
| | NOT APPLICABLE |
| 1.1.M | How to get access to professional repairers |
| | NOT APPLICABLE |
| 1.1.N | Failures detection and required action (consumers approach) |

BEFORE THE FIRST USE

- Take the appliance and accessories out of the box. Remove the stickers, protective foil or plastic from the device.
- Place the hose in the vacuum cleaner and turn it clockwise to secure. Place the other side of the hose into the tube.
- Only use the device if all the filters included the dustbag are placed properly, a damaged or improperly installed filter or dustbag may damage the unit.

USE

- Connect the various nozzles or floor brush to the tube for different cleaning purposes. The floor brush has two positions, soft/textile surfaces.
- Turn on the appliance: Hold the plug and pull out the cord, then insert the plug into the power socket. Make sure that the power supply corresponds to the required power mentioned on the rating label. Press the on/off switch pedal to turn on the power.
- The high power of the vacuum cleaner may cause that the floor brush will be sucked to the surface, when this happens please choose a lower sucking power.
- Turn off the appliance: After use, press the on/off switch pedal, the appliance is turned off. Pull the plug out of the power socket, press the cord rewinding pedal, the power cord will be drawn in.

1.1.0**User and maintenance instructions****CLEANING AND MAINTENANCE**

- The plug must be removed from the power socket before any maintenance or replacement.

Replacing the dust bag

- When the dust bag is full (check the indicator), please follow the instructions:
 - Open the front cover by pressing the lock clip
 - Lift off the Paper bag from the dust bag holder. Please always keep the dust inlet pointing upwards in order to void dust leakage.
 - Replace the dust bag and install a new dust bag to the holder. Make sure the card of dust bag reaches the bottom of the dust bag holder.
 - Close the front cover.

Cleaning the filters

- The motor protection filter(as found under the front cover) should be removed and rinsed twice a year or whenever it is visible clogged. If the filter is damaged, a new filter should be replaced.
- The exhausted filter (as found under the front cover) should be cleaned in time. Unclip the front cover and take out the Hepa filter, please use a soft bristled brush for cleaning.

